

Review of IOT_Smart Irrigation System using WebSocket Wireless Connection

Dr. Negm Eldin Mohamed Shawky

High Institute for Computers and Information Systems

Al- Shorouk Academy

Cairo – Egypt

e.mail: negmshawky@gmail.com

Abstract

This paper provides an overview of Smart Irrigation System based on internet of thing (IOT) using wireless connection of WebSocket protocol. This smart system is an automated system that uses sensors connected to a microcontroller to measure physical variables. The involved sensors in the system can be used to measure air temperature, water flow rate, soil moisture, humidity, control the water flow and detect the movement of any undesired object. Also, camera sensor can be used to follow up on daily events and actions in specified area for helping to manage proper procedures in agricultural operations. The measured data obtained from the sensors is processed by the microcontroller to be sent. The use of microcontroller is connected and controlled remotely through a smartphone or other mobile device. Wireless communication between microcontroller and smartphone can be achieved using a software program based on WeBSocket protocol to facilitate real time transfer of sensed data. Also all connected devices in the system can be programmed to display connected sensors measurement and to turn on and off at specific times or based on certain conditions, such as soil moisture levels or weather patterns. Using this review, implementing of smart irrigation system based on IOT can be clearly understood with achieving a good result of how to improve crop productivity, reduce water waste, accelerate performance and organize work by sending alerts or notifications to users in the event of any issues with making an appropriate decision.

Key Words: *Irrigation Systems, Internet of Things (IoT), Node MCU ESP8266, MobileApp, Soil Moisture Detector, WebSocket protocol*

1. Introduction

Smart irrigation system is a system to overcome the issues of traditional irrigation methods, such as the spread of harmful things that affect crop growth, flood irrigation and overhead sprinklers that could be inefficient and wasteful, leading to water loss and decreased crop yields. The increasing demand for water resources, coupled with the need to improve crop yields with protecting from harmful things and reduce water waste, require to the development of Smart Irrigation Systems. These systems use sensors, IoT devices, and other technologies to collect and analyze data on soil moisture, weather patterns, and other environmental factors, allowing for more efficient and precise irrigation. Smart irrigation using IoT is a way of using sensors, controllers, and actuators to optimize the use of water and fertilizers in agriculture [1,2]. IoT devices can monitor the soil moisture, temperature, humidity, and other environmental factors, and send the data to a cloud server or a local controller. Based on the data, the irrigation system can automatically adjust the amount of water and nutrients delivered to each plant or crop. This can save water, improve crop quality and yield, and reduce labor costs.

Smart Irrigation Systems offer a more sustainable and efficient solution by optimizing water usage based on real-time data and environmental conditions. Today, Smart Irrigation Systems are used in a variety of settings, from small-scale farms to large commercial operations. These systems can be customized to meet the specific needs and requirements of the irrigation, and can provide valuable data and insights to farmers, water managers, and other stakeholders.

The Smart Irrigation System is motivated by the following factors, required to be satisfied: -

- Water conservation by reducing water waste and ensuring that plants receive the right amount of water at the right time.
- Sustainability by reducing the carbon footprint of irrigation,
- Improved crop yield by providing the right amount of water to the plants at the right time.
- Technological innovation by using sensors, weather data, algorithms, and remote control and monitoring
- Climate change by the need to adapt to the effects of climate change, such as droughts and water scarcity. The system can help farmers and other plant-based industries to cope with the increasing unpredictability of weather patterns and ensure that plants receive the right amount of water to thrive,
- Economic benefits by reducing labor costs, improving crop yield, and promoting sustainable agriculture practices, the system can help to increase profits for farmers and other plant-based industries.

Some common microcontrollers or modules as Arduino UNO, ESP8266 NodeMCU, and Arduino Mega [3-4] can be used for implementing IOT irrigation system. In this paper, IOT building irrigation system as in figure 1 is provided by choosing ESP8266 Node multipoint control unit (MCU) module with several of different sensors such as digital temperature and humidity sensor (DTH11) sensor, water flow sensor, soil moisture sensor, ultrasonic sensor and camera. [5]. Also thing speak server is used to receive the moisture level in the soil, to monitor the land condition with remotely control using web or mobile application for Sprinkler system that is based on amount of the water flows through the tubes and water the plants according to their needs. The necessary water based on the land environmental conditions such as moisture, temperature and humidity can be identified by the smart system and the power will be switched on to provide enough water to the plants. The automated systems which are already implemented has the limitations like sending the alert message or

the SMS to the mobile. The aim of the paper is to review how to provide smart irrigation system with automated devices connected to each other through Wi-Fi for transmit and receive messages and to control the system with monitoring all the environment.

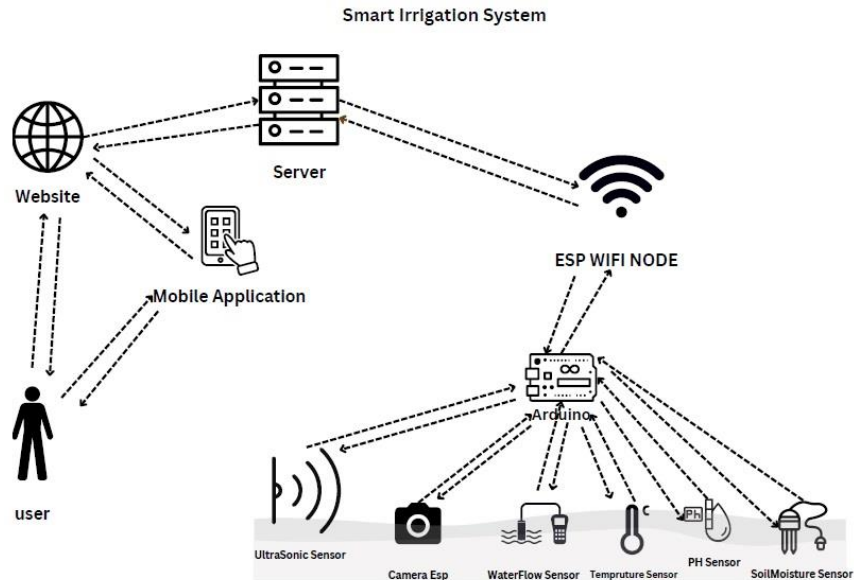

Figure 1. General system diagram

2. Related Work

There are some examples of smart irrigation systems using IoT with different features were published in the last period: -

- IoT based Smart Irrigation System using Soil Moisture Sensor and ESP8266 NodeMCU[6]: This system uses an ESP8266 NodeMCU module and a DHT11 sensor to measure the soil moisture and temperature, and control a water pump using a relay module. The system also sends the data to ThingSpeak Server, where it can be monitored from anywhere in the world using a smartphone app.
- Smart Irrigation System Using Internet of Things[7]: This system uses an Arduino Mega 2560 and a Blynk app to process the data from a soil moisture sensor and a DHT11 sensor, and automatically water the plant. The system also displays the real-time condition of the soil on the smartphone app that is connected to the internet.
- How to Build an IoT Solution for an Agricultural Irrigation System[8]: This article explains how irrigation systems using IoT can make agriculture and water management smarter, more efficient, resilient and sustainable. It also describes the key benefits, features and business outcomes of such systems.
- Smart Irrigation Using Internet of Things[9]: This paper investigates the concept of smart irrigation system using IoT, and develops a system that uses precise control of photoperiod, and soil and environmental sensors to reduce the cost of energy and increase yields.
- Smart Irrigation System using Internet of Things (IoT) and Machine Learning [10]: This paper proposes a smart irrigation system that uses NodeMCU to wirelessly operate a network of irrigation modules by measuring the water content of soil and checking the

condition of plant using a camera. The paper also provides insight on how to keep the integrity of data that travels from NodeMCU to user smartphone using ciphering methods.



3. Working Principle





There are many ways to implement a smart irrigation system using IoT, depending on the hardware and software components that can be used. Here are some possible steps required for implementing the system:

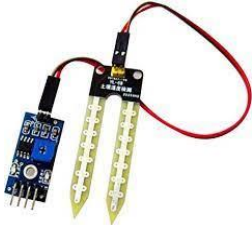

3.1 Choosing all Available Sensors Used in Irrigation System

Smart irrigation system requires to sensors that are illustrated as in the following table to measure the soil moisture by using soil moisture sensor, temperature and humidity by using DHT11 sensor, flow rate of water by using water flow sensor, and other factors that affect the water needs of the plants by using water pump that deliver the water from water source. Also for detecting the presence of the strange (undesired) things or avoid water when movement using Ultrasonic sensor (HC-SR04), PIR sensor and camera sensor (Arducam Mega) can be used to monitor the changes or events that affect the growth of agricultural crops.

Table 1: sensors used in irrigation system

Sensor Name	Picture	Function
Soil moisture Sensor [11]		Soil moisture sensors are devices that are used to measure the amount of moisture or water content in soil.
DHT11 sensor [12]		<p>The DHT11 sensor is a temperature and humidity sensor that is commonly used in electronics projects, particularly in the field of Internet of Things (IoT).</p> <p>Good for 20-80% humidity readings with 5% accuracy. Good for 0-50°C temperature readings $\pm 2^\circ\text{C}$ accuracy.</p> <p>The DHT11 sensor is placed in the soil or in close proximity to the plants to sense the temperature and humidity of the surrounding environment.</p>

<p>BME280 sensor[13]</p>		<p>The BME280 sensor module reads barometric pressure, temperature, and humidity. Because pressure changes with altitude, you can also estimate altitude. There are several versions of this sensor module but The BME280 can play a crucial role in smart agricultural systems, especially for irrigation management.</p> <p>Compared with DHT11 sensor, we recommend using the BME280 sensor due to its higher accuracy, wider temperature range, and additional barometric pressure measurement capability.</p>
<p>Water flow sensor [14]</p>		<p>A water flow sensor is an electronic device that is used to measure water flow rate. Furthermore, the flow rate means the volume of water passes through a sensor per unit of time. There are many types of water flow rate measurement sensors available in the market such as YF-B1, YF-B2, YF-B3, YF-B4, YF-B5, YF-B6, G1&2, G3&4, G1&8, and YF-S201. All these sensors are almost the same except for the difference in flow rate range, operating voltage range, length, size, and material used. But their working principle and the procedure to interface with microcontrollers such as Arduino remains the same.</p>
<p>PIR sensor [15]</p>		<p>Detecting movement: A PIR sensor can be used to detect the movement of animals or people in the vicinity of the irrigation system. If the system is set up to avoid watering when there is movement, the PIR sensor can help to prevent water waste and reduce costs.</p> <p>A PIR sensor can be used to detect plant growth by measuring the infrared radiation emitted by the plants. This can help to optimize the watering schedule based on the growth rate of the plants.</p>
<p>Water pump[16]</p>		<p>The water pump delivers water from a water source, such as a well or a municipal water supply, to the irrigation system. The pump can be controlled by a microcontroller or other processing unit to ensure that the flow of water is optimized based on the specific needs of the plants.</p>

<p>HC-SR04 Module [17]</p>		<p>HC-SR04 is an Ultrasonic sensor module which includes ultrasonic transmitter, receiver and control circuit in single compact PCB. HC-SR04 has distance measurement ability ranging from 2cm to 400cm. These small units are very accurate, and its accuracy can be reach up to 3mm.</p> <p>Ultrasonic modules work on the principle similar to radar or sonar- sensors. It generates high frequency signals from the transmitter of about 40kHz towards the sensing object and receives echo signal back to the receiver. Then we can calculate object distance using time interval between the sending of signal and the receiving of echo pulse.</p>
<p>Rain sensor [18]</p>		<p>Rain Sensors also called raindrop sensors are very handy sensors that are used in a variety of use cases. Alone a rain sensor can only detect if it is raining and how strong it rains but in combination with other electrical devices you can build useful applications.</p> <p>The rain sensor consists of 2 components, which we consider it below:</p> <ul style="list-style-type: none"> - Rain drop module to detect if it is raining or not - Control board to process the data from the rain drop module
<p>Arducam Mega 5MP SPI Camera [19]</p>		<p>It fits any Microcontroller with a standard SPI interface (either native or mimic one), 8-bit, 16-bit or 32-bit, ARM, RISC-V, or others.</p> <p>Only six pins are required.</p> <p>No memory is needed for register settings or frame buffers.</p> <p>Fully compatible with 3.3 and 5V systems Arduino, Raspberry Pi Pico, STM8/STM32, ESP8266/ ESP32, MSP430, MicroChip, micro: bit and countless more.</p>

3.2 Choosing the ESP8266 module for reading data from connected sensors

There are different types of microcontroller or module that can be used to process the data from the sensors and control the irrigation valves or pumps, for simplicity we choose one of the microcontrollers (ESP8266 module) to illustrate how the connection and implementation between it and sensors can be occurred. The ESP8266 module is described as in the following table.

Table 2: ESP8266 module and its description

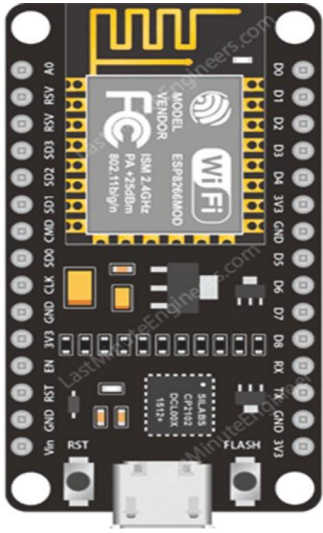
Name/picture	Description
<p style="text-align: center;">ESP8266 module</p> 	<p>The ESP8266 module is a WiFi-enabled microcontroller data collection: The ESP8266 module can be used to collect data from various sensors and inputs in the irrigation system, such as soil moisture sensors, weather sensors, and water flow sensors. This data can be used to optimize the watering schedule and adjust irrigation levels based on the specific needs of the plants.</p> <p>The ESP8266 module can transmit the data collected by the sensors to a central control unit or cloud-based platform. This enables remote monitoring and control of the irrigation system, as well as real-time data analysis and reporting.</p> <p>The ESP8266 module can be used to remotely control various components of the irrigation system, such as valves and pumps.</p>

Here is the PIN map of ESP8266, just for your information [20]

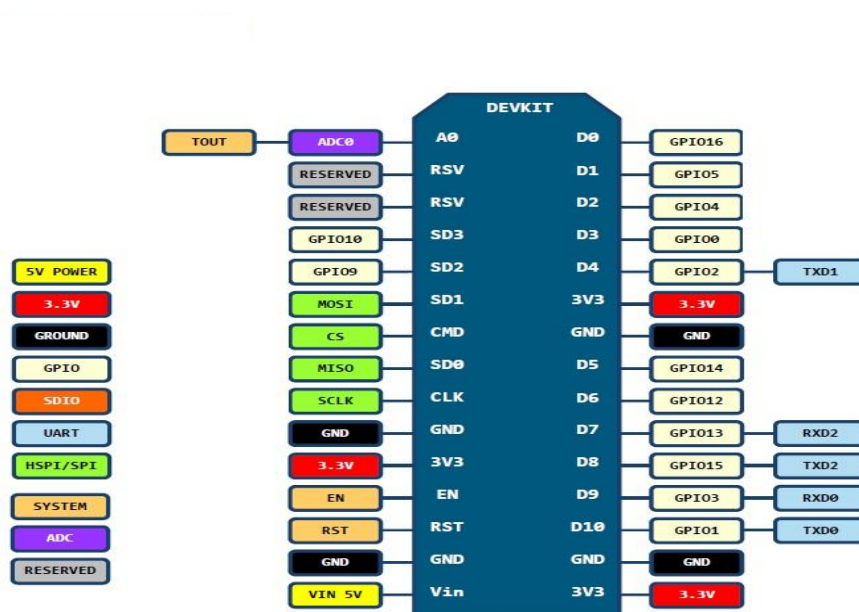
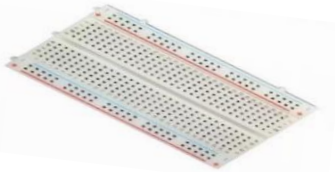



Figure2: Pin assignment of ESP8266 board.

Based on selecting microcontroller additional steps are required as in the following:

- The wireless communication protocol to be used to transmit the data from the microcontroller or module to the internet or a cloud platform. Some common wireless communication protocols are Wi-Fi, Zigbee, and LoRa125 [21].
- The sensors require to be connected with the microcontroller or module using jumper wires and a breadboard that are described as in the following table. This may also need some resistors, capacitors, and LEDs for your circuit.

Table 3: breadboard and jumper wires with its description

Name/picture	Description
<p style="text-align: center;">Breadboard</p> 	<p>Assembling circuits: Electronic components can be connected and assembled on the breadboard to create electronic circuits that perform specific functions, such as measuring soil moisture or controlling irrigation valves.</p>
<p style="text-align: center;">Jumper Wires</p> 	<p>Jumper wires can be used to connect sensors, such as soil moisture sensors or temperature sensors, to the microcontroller or processing unit in the system. This allows the sensors to transmit data to the microcontroller for processing and analysis.</p> <p>Jumper wires can also be used to connect actuators, such as solenoid valves or pumps, to the microcontroller or processing unit. This allows the microcontroller to control the flow of water to the irrigation system based on the specific needs of the plants.</p>

3.3 Connection of irrigation sensors to ESP8266 module (Hardware design)

The irrigation sensors can be connected to the microcontroller or module using relays or transistors. This also needs a power supply for the irrigation system as in the following.

3.3.1 Connecting soil moisture sensor to the ESP8266 [22]

Soil moisture sensor consist of two components (probe and circuit board)

Using sensor pins of circuit board:

VCC – Connected to Arduino 5V output.

GND – Connected to Arduino GND.

DO – Digital Output

AO – Analog Output

can be connected to ESP8266 board as in the following figure

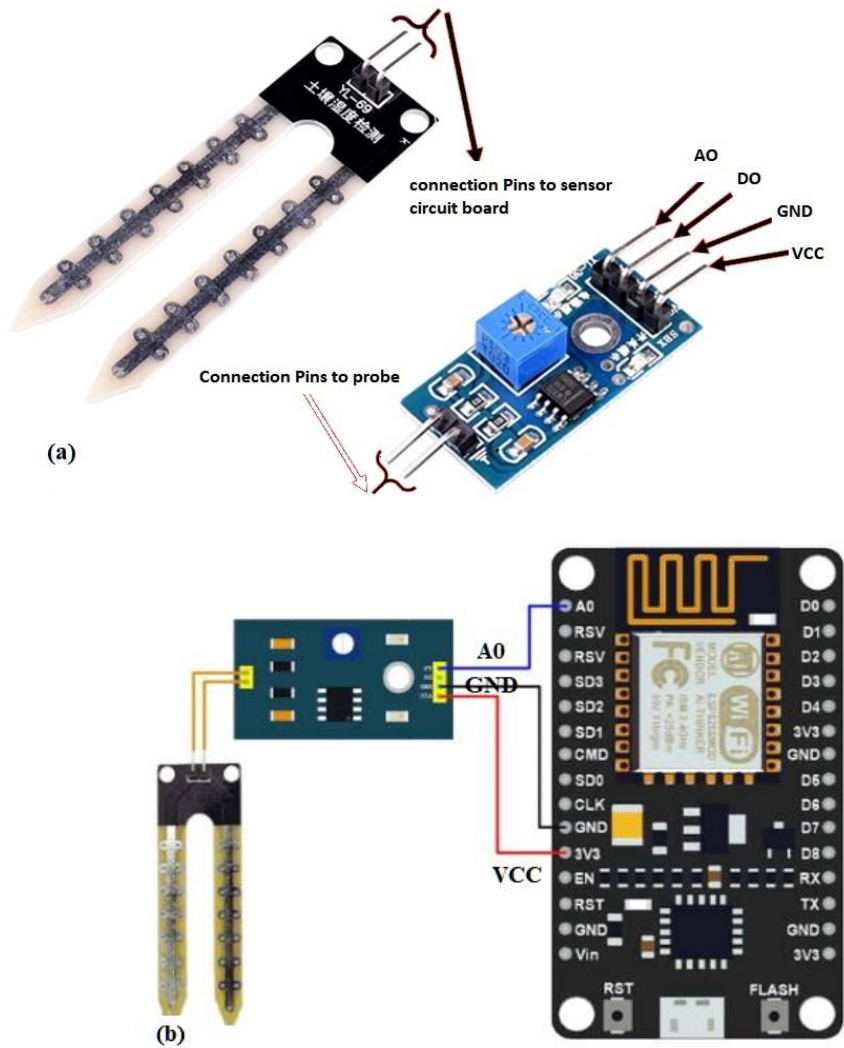

Figure3: (a)connecting of pin probe to sensor circuit board , (b) connecting of pins to ESP8266 board

3.3.2 Connecting DHT11 sensor to the ESP8266 [22]

The following figure show how DHT11 sensor connected to ESP8266 board

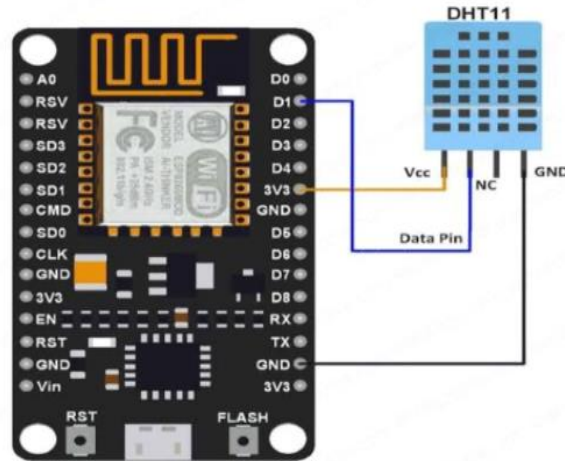

Figure 4: connecting of DHT11 sensor pin to ESP8266 board

There is a table to illustrate the connection of sensor with ESP8266 board

Table 4: sensor pin connecting to esp8266 pin assignment

Esp8266	Dht11 Sensor
VV, Vin (+5V)	(V) VCC (Positive +)
G, GND (Ground)	(G) GND (Ground -)
D4 Pin	(S) OUT Pin

3.3.3 Connecting BME280 sensor module to the ESP8266 [23]

BME280 sensor communicates using I2C communication protocol, so the wiring is very simple. You can use the default ESP8266 I2C pins as shown in the following table:

Table5: BME280 sensor pins connecting to ESP8266 pin assignment

BME280	ESP8266
SCK (SCL Pin)	GPIO 5

BME280	ESP8266
SDI (SDA pin)	GPIO 4
VCC(Vin)	3.3V
GND	GND

Sensor pins can be connected

to ESP8266 board as in the following figure

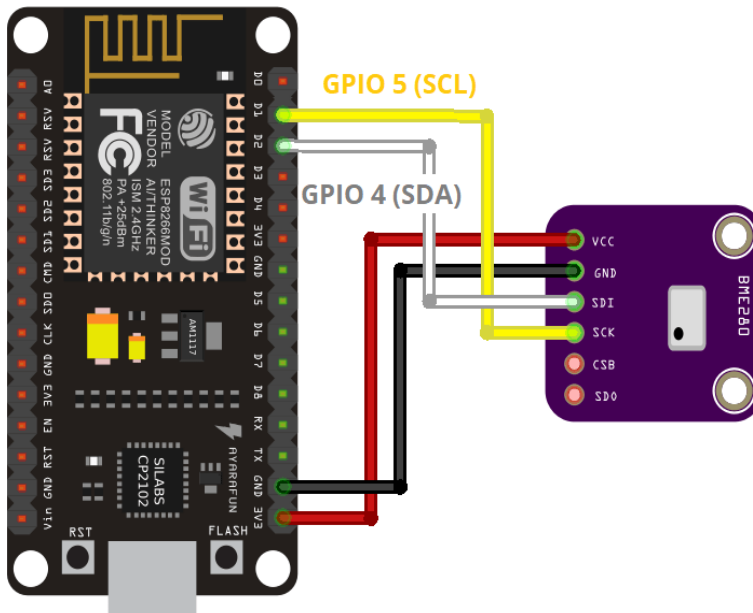

Figure 5 connecting of BME280 sensor pin to ESP8266 board

3.3.4 Connecting water flow sensor to the ESP8266 [24]

Water Flow Sensor is a digital Sensor, so we can connect its output pin to any of the digital pins of ESP8266 as in following figure

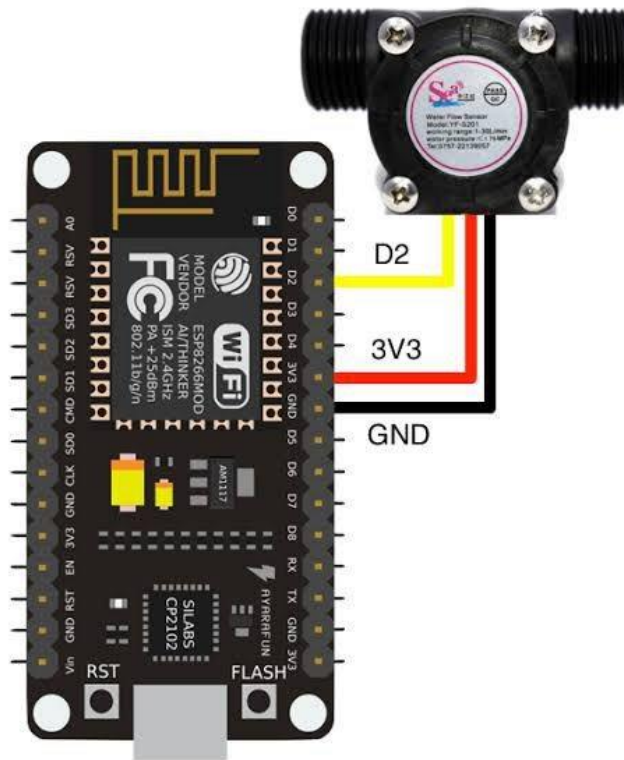

Figure 6: connecting of water flow sensor pin to ESP8266 board

Please refer to the table below for pin connections. you can connect the sensor to GPIO2, also known as D2. It is important to note that the sensor operates at 5V and can be connected to the Vin pin of the ESP8266.

Table 6: water flow sensor pins function connected to esp8266 board

Pin Number	Pin Name	Function
1	RED	5-24 VDC Positive POWER TO VCC
2	BLACK	Ground wire TO GND
3	YELLOW	Output Voltage wire TO D2

3.3.5 Connecting PIR sensor to the ESP8266 [25]

As we know from the following figure that the PIR sensor consists of three pins which are:

- VCC
- Out
- Ground

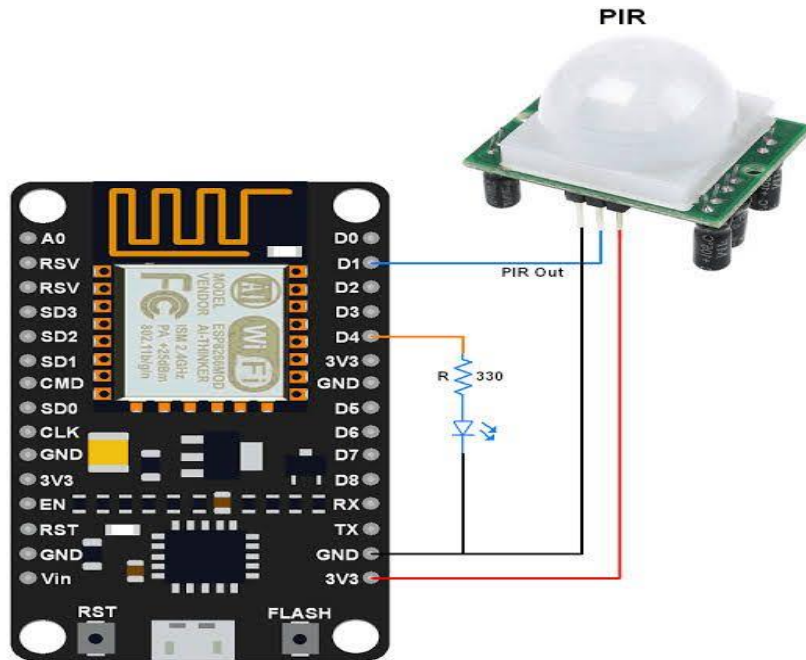

Figure 7: connecting of PIR sensor pin to ESP8266 board

So connect the VCC pin of the PIR sensor with the 3.3V of the ESP8266 NodeMCU. Connect the Output pin of the PIR sensor with the digital pin 2 of the NodeMCU ESP8266 and connect the ground pin of the PIR sensor with the ground of the NodeMCU ESP8266.

3.3.6 Connecting water pump to the ESP8266 module [26]

Using Relay module, water pump can be connected to ESP8266 board as in the following figures:

Relay module

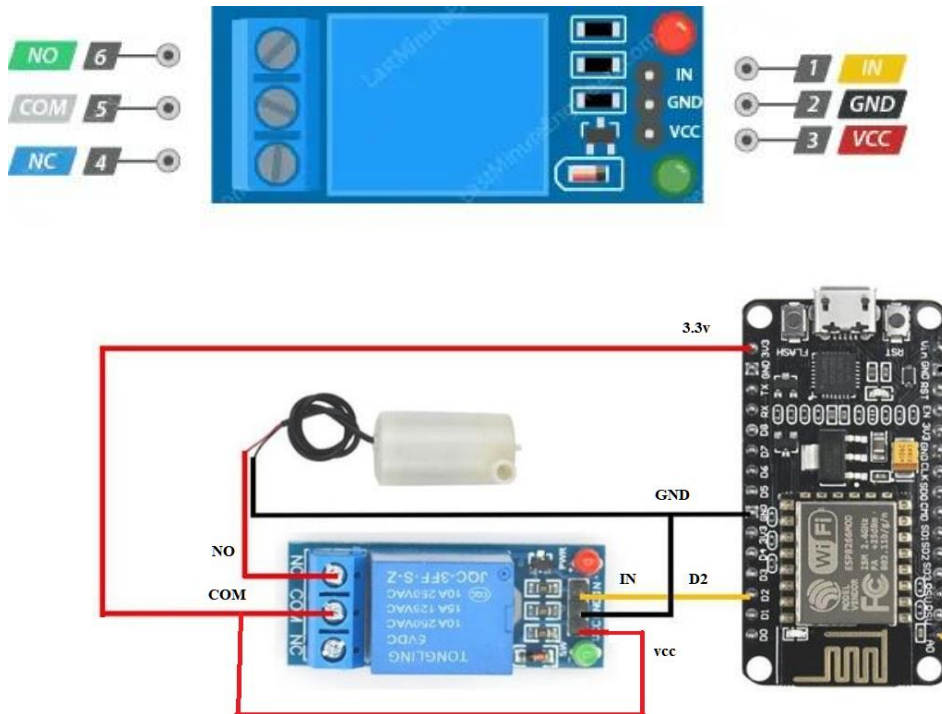

Figure 8: : connecting of Relay Module and Water Pump wiring to ESP8266 board

Pin function of relay module is illustrated in the following table

Table 7 : pin function of relay module:

Pin number	Pin name	Pin function
1	IN (control)	pin is used to control the relay. This is an active low pin, which means that pulling it LOW activates the relay and pulling it HIGH deactivates it.
2	GND (power)	the common ground pin
3	VCC (power)	pin provides power to the module.

4	NC (output)	terminal is normally connected to the COM terminal, unless you activate the relay, which breaks the connection.
5	COM (output)	terminal connects to the device you intend to control.
6	NO (output)	terminal is normally open, unless you activate the relay that connects it to the COM terminal.

Relay Module and Water Pumps interfacing with the NodeMCU ESP8266

- The VCC pin on the Relay Module connects to a 3v3 pin on the ESP8266.
- The GND pin on the Relay Module connects to a GND pin on the ESP8266.
- The IN pin on the Relay Module connects to pin D2 on the ESP8266.
- The NO pin on the Relay Module connects to the red wire on the Water Pumps.
- The COM pin on the Relay Module connects to a 3v3 pin on the ESP8266.
- The black wire on the Water Pumps connects to a GND pin on the ESP8266.

3.3.7 Connecting HC-SR04 Module sensor to the ESP8266[27]

The following figure show how HC-SR04 Ultrasonic sensor connected to ESP8266 board

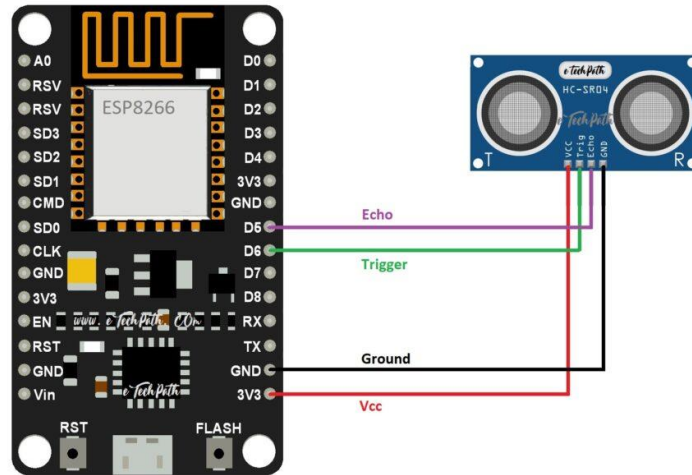

Figure 9: connecting of HC-SR04 Module sensor pin to ESP8266 board

Here's the pinout of the HC-SR04 Ultrasonic Sensor.as in the following tables.

Table 8: ultrasonic pin function

pin	function
VCC	Powers the sensor (5V)
Trig	Trigger Input Pin
Echo	Echo Output Pin
GND	Common GND
GND	Common GND

Table 9: ultrasonic pin sensor connected to esp8266 board

Ultrasonic Sensor	ESP8266
VCC	VIN
Trig	GPIO 12 (D6)
Echo	GPIO 14 (D5)
GND	GND

3.3.8 Connecting rain detector sensor to the ESP8266[28]

Rain detector sensor can be connected to ESP8266 board as in the following figure

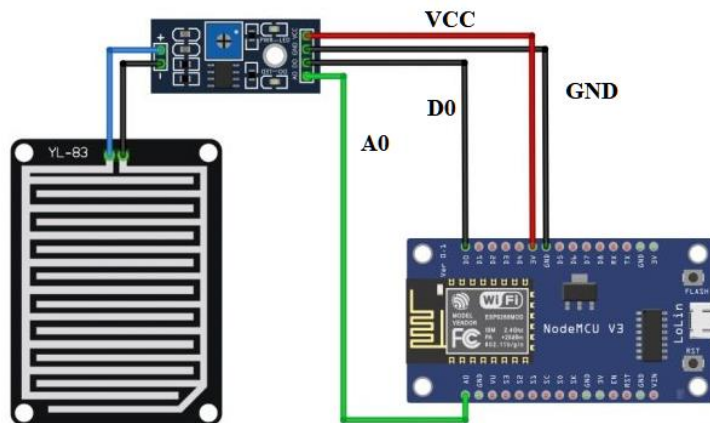

Figure 10: connecting of rain sensor (Rain drop module+ control board) Module sensor pin to ESP8266 board

Rain sensor interfacing with the NodeMCU ESP8266:

- Connect the VCC of the rain sensor with the 3.3V
- Connect the ground of the rain sensor with the ground of the NodeMCU
- Connect the digital pin of the rain sensor with the D0 of the NodeMCU
- Connect the A0 pin of the rain sensor with the A0 of the NodeMCU

3.3.9 Connecting Camera sensor to the ESP8266 [29]

Arducam Mega is selected as a camera type can work with any microcontroller with a single standard SPI interface. Only 4 pins (GPIOs) are required excluding VCC & GND. The camera is specially designed for energy-saving applications. You can completely switch off the camera when your MCU is sleeping, without worrying about loading long register settings, as it does for you instantly (less than 100 ms) and automatically. There are two versions of Arducam Mega cameras, one with 3MP(fixed focus) and the other with 5MP(autofocus). It comes with a default enclosure; you can mount it easily wherever you want. Now let us see how we can interface 5 megapixel SPI Camera called Arducam Mega with NodeMCU ESP8266. The connection diagram is fairly simple as shown in the image below.

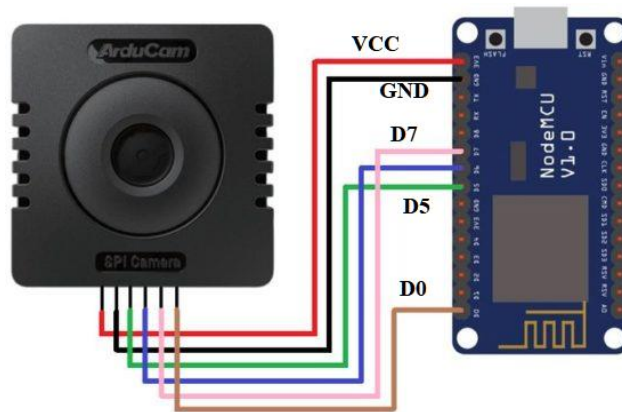

Figure 11 connecting of camera sensor(Arducam Mega5MP) pins to ESP8266 board

And the following table illustrate the pin assignment of connection between camera and ESP8266

Table 10: camera pin connected to esp8266 board

Camera Pin	NodeMCU ESP8266 Board
VCC	3.3V

Camera Pin	NodeMCU ESP8266 Board
GND	GND
SCK	D5
MISO	D6
MOSI	D7
CS	D0

3.4 Creating WebSocket to display the reading of sensors on web page

To display the reading of sensors on web page there are a sequence number of steps that must be taken as in the following:

- (1) Connect the microcontroller or module to the internet using a Wi-Fi router.
- (2) Program your microcontroller or module using an IDE (Integrated Development Environment) such as Arduino IDE or NodeMCU PyFlasher..
- (3) Upload your code to your microcontroller or module using a USB cable.
- (4) Configure your application using a web browser or a smartphone app.

In this case we need to create a WebSocket server with the ESP8266 NodeMCU board to display sensor readings on a web page [30-32].



Figure 12 websocket for exchange data between ESP8266 and web or mobile app.

A WebSocket is a persistent connection between a client and a server that allows bidirectional communication between both parties using a TCP connection. This means data can be sent from the client to the server and from the server to the client at the same time.

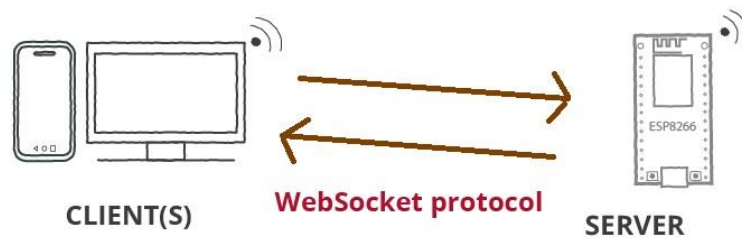

Figure 13 bidirectional communication using websocket protocol

The client establishes a WebSocket connection with the server through a process known as *WebSocket handshake*. The handshake starts with an HTTP request/response, allowing servers to handle HTTP connections as well as WebSocket connections on the same port. Once the connection is established, the client and the server can send WebSocket data in full duplex mode.

Using the WebSockets protocol, the server (ESP8266 board) can send information to the client or to all clients without being requested. This also allows for the information to be sent to the web browser when a change occurs. This change can be occurred on the web page (you clicked a button) or something that happened on the ESP8266 side like pressing a physical button on a circuit, or new sensor readings available.

Two ways for the reading of the sensor from ESP server that transmitted to a client on web page.

(1) The webpage in client sends a message (*GetReading*) to the ESP via WebSocket protocol. The ESP server receives that message. When that happens, it gets new readings from the sensors and sends them back to the client (web browser), also via web socket protocol. This way, current and updated values are displayed on webpage

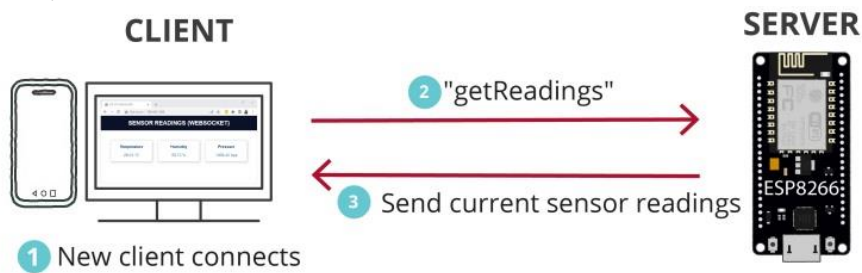

Figure 14:two way communication for reading data on web page

(2) Every 20 seconds, the ESP gets new readings and sends them to all connected clients (all web browser tabs opened) via WebSocket protocol. The client receives that message and displays the readings on the web page.

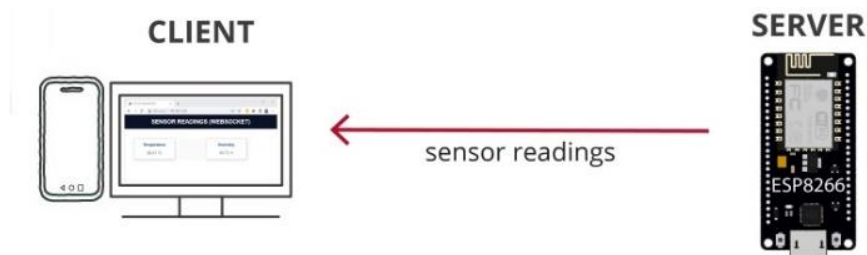

Figure15::one way communication for reading data on web page

To understand how to exchange data between client and server using WebSocket connection in programming code of JavaScript. Let's assume we need to do the following and how it works:

- initializes a WebSocket connection with the server;
- sends a message to the server to get the current sensor readings;
- uses the response to update the sensor readings on the web page;
- handles data exchange through the WebSocket protocol.

Using a code of JavaScript:

```
var HostName = ws://${ window.location.hostname }/ws;
```

The `HostName` is the entry point to the WebSocket interface. `window.location.hostname` gets the current page address (the web server IP address).

```
var websocket;
```

Create a new global variable called `websocket`

```
window.addEventListener('load', onload);
```

Add an event listener that will call the `onload` function when the web page loads.

```
function onload(event) {  
  initWebSocket();  
}
```

The `onload()` function calls the `initWebSocket()` function to initialize a WebSocket connection with the server.

```
function initWebSocket() {  
  console.log('Trying to open a WebSocket connection...');  
  websocket = new WebSocket(HostName);  
  websocket.onopen = onOpen;  
  websocket.onclose = onClose;  
  websocket.onmessage = onMessage;  
}
```

The `initWebSocket()` function initializes a WebSocket connection on the `HostName` defined earlier. We also assign several callback functions for when the WebSocket connection is opened, closed, or when a message is received.

```
function onOpen(event) {
  console.log('Connection opened');
  getReadings();
}
```

Note that when the WebSocket connection is open, we'll call the `getReadings` function.

```
function getReadings(){
  websocket.send("getReadings");
}
```

The `getReadings()` function sends a message to the server `getReadings` to get the current sensor readings. Then, we must handle what happens when we receive that message on the server side (ESP8266).

```
// Function that receives the message from the ESP8266 with the readings
function onMessage(event) {
  console.log(event.data);
  var myObj = JSON.parse(event.data);
  var keys = Object.keys(myObj);

  for (var i = 0; i < keys.length; i++){
    var key = keys[i];
    document.getElementById(key).innerHTML = myObj[key];
  }
}
```

the `onMessage()` function the messages received is handled via WebSocket protocol on. The server sends the readings in JSON format, for example:

```
{
  temperature: 24;
  humidity: 40;
  pressure: 180;
}
```

The `onMessage()` function simply goes through all the key values (`temperature`, `humidity`, and `pressure`) and places them in the corresponding places on the web page by the following code:

```
for (var i = 0; i < keys.length; i++){
  var key = keys[i];
```

```
document.getElementById(key).innerHTML = myObj[key];  
}
```

Based on the previous information as mentioned above, smart irrigation systems are needed to optimize water usage for irrigation purposes, while also ensuring that plants receive the appropriate amount of water. Here are some considerations should be taken in the future of additional functional requirements for designing of a smart irrigation system:

1. The system should be able to control the rate and volume of water flow to different parts of the irrigation system. This can help to ensure that water is distributed evenly and efficiently.
2. The system should be able to measure soil moisture levels and adjust watering accordingly. This can be done using sensors that are placed in the soil.
3. The system should have a mobile app interface that allows users to monitor and control the system remotely.
4. The system should have an automatic shut-off feature that stops watering when it is not necessary, such as during rain or when soil moisture levels are sufficient.
5. The system should be able to send alarm notifications to users in case of any malfunction, such as a broken pipe or a failed sensor. This can help to quickly identify and resolve any issues before they cause significant damage.
6. The system should allow users to define customized watering zones based on the specific needs of their landscape. This can help to ensure that different types of plants receive the appropriate amount of water.

4. Conclusion

In this paper, an overview of all possible components required of hardware and software to implement smart irrigation system using IOT by Arduino NodeMCU ESP8266. The implementation of this system include the study of the required sensors and the connection with the Arduino board. Some of the sensors was used for obtaining the measurement of temperature ,humidity, the amount of moisture in the soil, water flow rate and the other of the sensors for observing the rainfall, detecting the movement of animals or people and monitor everything using camera connected to the system for monitoring the events with introducing protection against undesired objects that helps to take a right decision, Also this paper includes wireless communication using of WebSocket protocol for receiving data from the sensors and transmit the sensed data to client or mobile app. This overview helped as much as implementation of smart irrigation system with obtaining the results of reducing costs to the farmer and people have gardens in their house and Improving water efficiency by providing more precise and efficient control over irrigation this lead to Improving Plant Health by providing the right amount of water at the right time.

References

- [1] Dr. C K. Gomathy, Mr. A. Vamsikumar, Mr. B. Karthik, Mr. A. Purushothamreddy, “The Smart Irrigation System Using Iot”, International Research Journal of Engineering and Technology (IRJET) , Volume: 08 Issue: 10 | Oct 2021 ,www.irjet.net p-ISSN: 2395-0072, e-ISSN: 2395-0056

- [2] A Kalyan Kumar Jena* , Sourav Kumar Bhoi, Mahesh Kumar Nayak , “ Smart Watering System Using IoT “, Pramana Research Journal,Volume 9, Issue 3, 2019,ISSN NO: 2249-2976
- [3] Posholi Fusi Gabriel; Zenghui Wang,” Design and Implementation of Home Automation system using Arduino Uno and NodeMCU ESP8266 IoT Platform”, International Conference on Advanced Mechatronic Systems (ICAMechS) , IEEE, January 2023.
- [4] Kolpe Gauri, Gosavi Rutuja, Fatate Vaishnavi, Rohit Bhosale, Shriprasad Chate, Akshay Lad and Prof. Santosh Gadekar, ” arduino uno-atmega328 p microcontroller based smart systems” , 3rd International Conference on Communication and Information Processing (CCIP-), owned by Elsevier , 2021
- [5] Dlnya Abdulahad Aziz ,“ Websrver Based Smart Monitoring System Using ESP8266 Node MCU Module”, International Journal of Scientific and Engineering Research, Vol. 9, Issue 6,June 2018
- [6] Ms.S.Shobana, B. Sanjana Pandey, Padmashri.R, U.Triveni, “Iot Based Smart Irrigation System Using Soil Moisture Sensor And Esp 8266 NODEMCU “, international Journal of Computer Science and Information Technology Research , Vol. 9, Issue 2, pp: (52-58), Month: April - June 2021.
- [7] Nor Adni Mat Leh,Muhammad Syazwan Ariffuddin Mohd Kamaldin,Zuraida Muhammad,Nur Atharah Kamarzaman, ” Smart Irrigation System Using Internet of Things” , IEEE 9th International Conference on System Engineering and Technology (ICSET), October 2019.
- [8] Digiteum Team, ”How to Build an IoT Solution for an Agricultural Irrigation System”, Dec 16, 2019.
- [9] Nor Adni Mat Leh,Muhammad Syazwan Ariffuddin Mohd Kamaldin;Zuraida Muhammad,Nur Atharah Kamarzaman, “Smart Irrigation Using Internet of Things” , IEEE 9th International Conference on System Engineering and Technology (ICSET), 2019.
- [10] Sumit Badotra; Lokesh Gundaboina; Ansh Trehan; Devansh Mishra; Prakrit Srivastava; Anil Kumar Dhaiya”Smart Irrigation System using Internet of Things (IoT) and Machine Learning” , IEEE 9th International Conference on Reliability, Infocom Technologies and Optimization (Trends and Future Directions) (ICRITO), November 2021.
- [11] Limin Yu ;Wanlin Gao; Redmond R. Shamshiri “Review of research progress on soil moisture sensor technology”, International Journal of Agricultural and Biological Engineering, August 2021.
- [12] Gaurav Verma; Pranjul Mittal; Shaista Farheen , “Real Time Weather Prediction System Using IOT And Machine Learning” , IEEE , 6th International Conference on Signal Processing and Communication (ICSC), September 2020
- [13] Bosch Sensortech, “BME280 ‘combined humidity and pressure sensor’ bme280 – data sheet.” pp. 1–55, 2020. [Online]. Available: <https://www.bosch-sensortec.com/media/boschsensortec/downloads/datasheets/bst-bme280-ds002.pdf>
- [14] Pushkar Singh; Sanghamitra Saikia, “Arduino-based smart irrigation using water flow sensor, soil moisture sensor, temperature sensor and ESP8266 WiFi module , IEEE Region 10 Humanitarian Technology Conference (R10-HTC) , April 2017 .
- [15] M. Pavithra, “IOT Home Automation with PIR Sensor Security using ESP8266 WI-FI Chip and GSM “ , International Journal of Advanced Research in Computer Engineering & Technology (IJARCET) , Volume 8, Issue 6, June 2019.

- [16] Apurva Ushire, Dr. R. C. Jaiswal, “Real Time Water Monitoring System Using NodeMCU ESP8266 “Journal of Emerging Technologies and Innovative Research (JETIR), Vol. 9, Issue 9, September 2022.
- [17] Anak Agung Ngurah , “Water Level Detection System Based on Ultrasonic Sensors HC-SR04 and ESP8266-12 Modules with Telegram and Buzzer Communication Media Hanan* , IIETA, Vol. 18, No. 3, pp. 305-309 , June, 2019.
- [18] Siti Dalilah Hashim; Muhamad Hariz Muhamad Adnan; Nor Masharah Husain, “Rain Monitoring and Prediction System Using Iot “Aip Conf. Proc., March 23 2023.
- [19] “Arducam Mega SPI Camera for Any Microcontroller “Published in March 2022 by Arducam Technology co, <https://www.arducam.com/downloads/arducam-mega-product-brief.pdf>
- [20] <https://poanchen.github.io/blog/2020/09/13/how-to-make-an-automotive-wi-fi-plant-watering-system-that-is-connected-to-azure-iot-central>
- [21] <https://www.aranacorp.com/en/create-a-web-interface-with-nodemcu-esp8266/>
- [22] Ms.S.Shobana, B. Sanjana Pandey, Padmashri.R, U.Triveni , “ Iot Based Smart Irrigation System Using Soil Moisture Sensor And Esp8266nodemcu”, International Journal of Computer Science and Information Technology Research ISSN 2348-120X ,Vol. 9, Issue 2, pp: (52-58), Month: April - June 2021.
- [23] Andriy Holovatyy, “Development of IoT Weather Monitoring System Based on Arduino and ESP8266 Wi-Fi Module “ , IOP Conf. Series: Materials Science and Engineering 1016 (2021) 012014 , doi:10.1088/1757-899X/1016/1/012014
- [24] Nurhening Yuniarti; Universitas Negeri Yogyakarta Didik Hariyanto , “Design and Development of IoT Based Water Flow Monitoring for Pico Hydro Power Plant, International Journal of Interactive Mobile Technologies (iJIM) 15(7):69-80, April 2021 .
- [25] M. Pavithra, “IOT Home Automation with PIR Sensor Security using ESP8266 WI-FI Chip and GSM”, International Journal of Advanced Research in Computer Engineering & Technology (IJARCET) , Volume 8, Issue 6, June 2019, ISSN: 2278 – 1323
- [26] Dachel P. Raagas, Donn Emile Kylee M. Melgazo Engr Dave Christian S. Ergina Rommel L. Verccio “Smart water tank system using WIFI-based microcontroller unit “South Florida Journal of Development, Miami, v.3, n.2. p.2670-2685, 2022. ISSN 2675-5459 , DOI: 10.46932/sfjdv3n2-086
- [27] “Distance measurement with SR HC 04, NodeMcu ESP 8266 and Blynk” : <https://www.researchgate.net/publication/326580937> , July 2018 , DOI: 10.13140/RG.2.2.21334.34880
- [28] Mothukuri, Amogh, “IoT Based Weather Monitoring System” (September 6, 2021). Available at SSRN: <https://ssrn.com/abstract=3918133> or <http://dx.doi.org/10.2139/ssrn.3918133>
- [29] Ebook,” ESP8266 Robotics Projects DIY Wi-Fi controlled robots” By Pradeeka Seneviratne , November 2017 , ISBN 978-1-78847-461-0.
- [30] Ebook,” A Beginner's Guide to the ESP8266”, By Pieter P, 08-03-2017
- [31] Kolban’s book on ESP8266 by Neil Kolban jan2016.
- [32] Ebook,” Wireless Sensor System for Monitoring Sportsmen Exposed to Hazardous Concussions” BY Alper Idrisoglu, April 2019.